

PCB LAYOUT

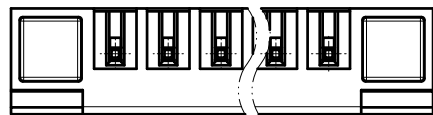

未注公差/General tolerances(mm)												0.1/10	
0	>3	>6	>10	>18	>30	>50	>80	>120	>180	>250	>315		>400
±0.12	±0.18	±0.22	±0.26	±0.31	±0.37	±0.57	±0.80	±0.93	±1.05	±1.15	±1.60	±2.20	±2.50
~	~	~	~	~	~	~	~	~	~	~	~	~	~
3	6	10	18	30	50	80	120	180	250	315	400	500	>500

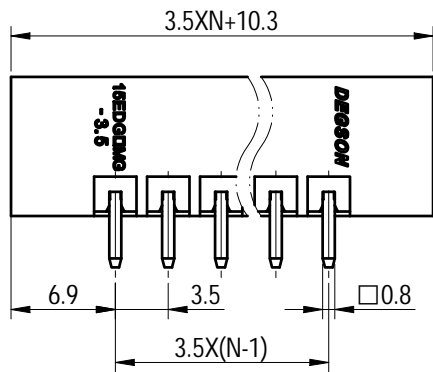
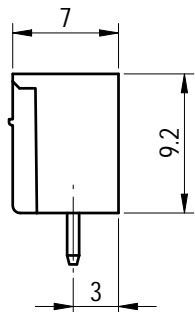
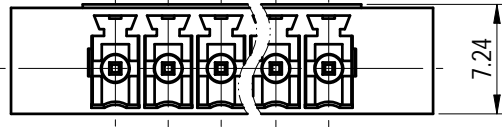
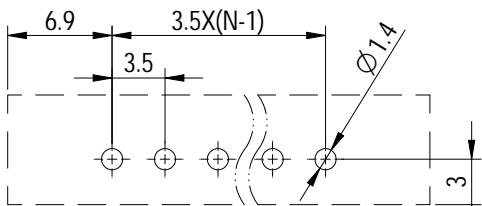
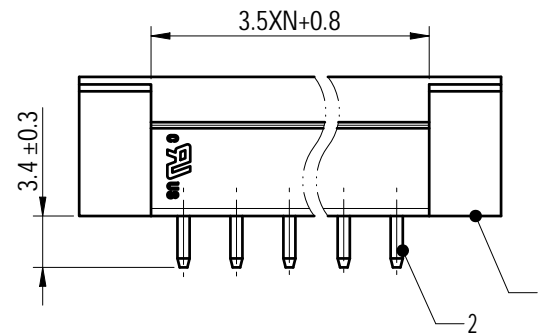
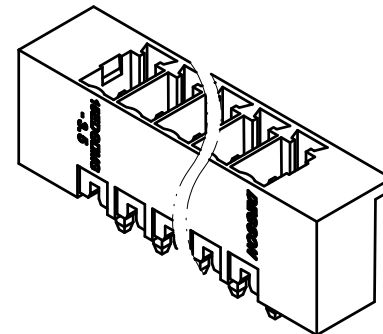

Note:
The A&Z(H) in the name means :A(H) and Z(H).

ITEM	NAME OF PART	MATERIAL	NOTES
2	Pin	Copper Alloy	Sn Plated
1	Housing	PA66	UL94V-0

UL 标准/UL Standard:	B	C	D
额定电压/电流/Rated Voltage(V)/Current(A)	300/8	/	300/8
IEC 标准/IEC Standard:			
过压类别/Overvoltage Category/污染等级/Pollution Degree	III/3	III/2	II/2
额定电压/电流/Rated Voltage(V)/Current(A)	/	/	250/7
额定脉冲电压(KV)/Rate Impulse Voltage(KV)	/	/	2.5
间距/Pitch(mm)/线数范围/Poles	3.5/N=02~12P		
使用温度范围/Operating temperature(°C)	-40~+105		
符合 RoHS 环保要求/Conform to RoHS	Yes		

		MATERIAL: /	SURFACE/COLOR: /	
APPD: 兰春华 2022.07.14		MAT NO./REV: - / 00		MAT STATUS: 批量
CHKD: 陈招 2022.07.13		NAME		
DRFT: 岑凯 2022.07.13		15EDGVMG-3.5-XXP-1Y-00A&Z(H)		
DRAWING NO.	TYPE	DRAWING STATUS	SCALE	SHEET
200042176	CUSTOMER DRAWING	已发布	2:1	1/1

REV	ECN	DESCRIPTION	DRFT	DATE
00		1X初版发行	岑凯	2022.07.13

Transfer or duplication of this document as well as the utilization or communication of its contents are prohibited unless authorized. All rights reserved for patent, utility model or designs registrations. 非经书面明确授权, 严禁禁止转让、复制、利用、交加本文件的内容, 一经发现将追究法律责任。本公司保留对本项专利的所有权利。